

G13-M2L

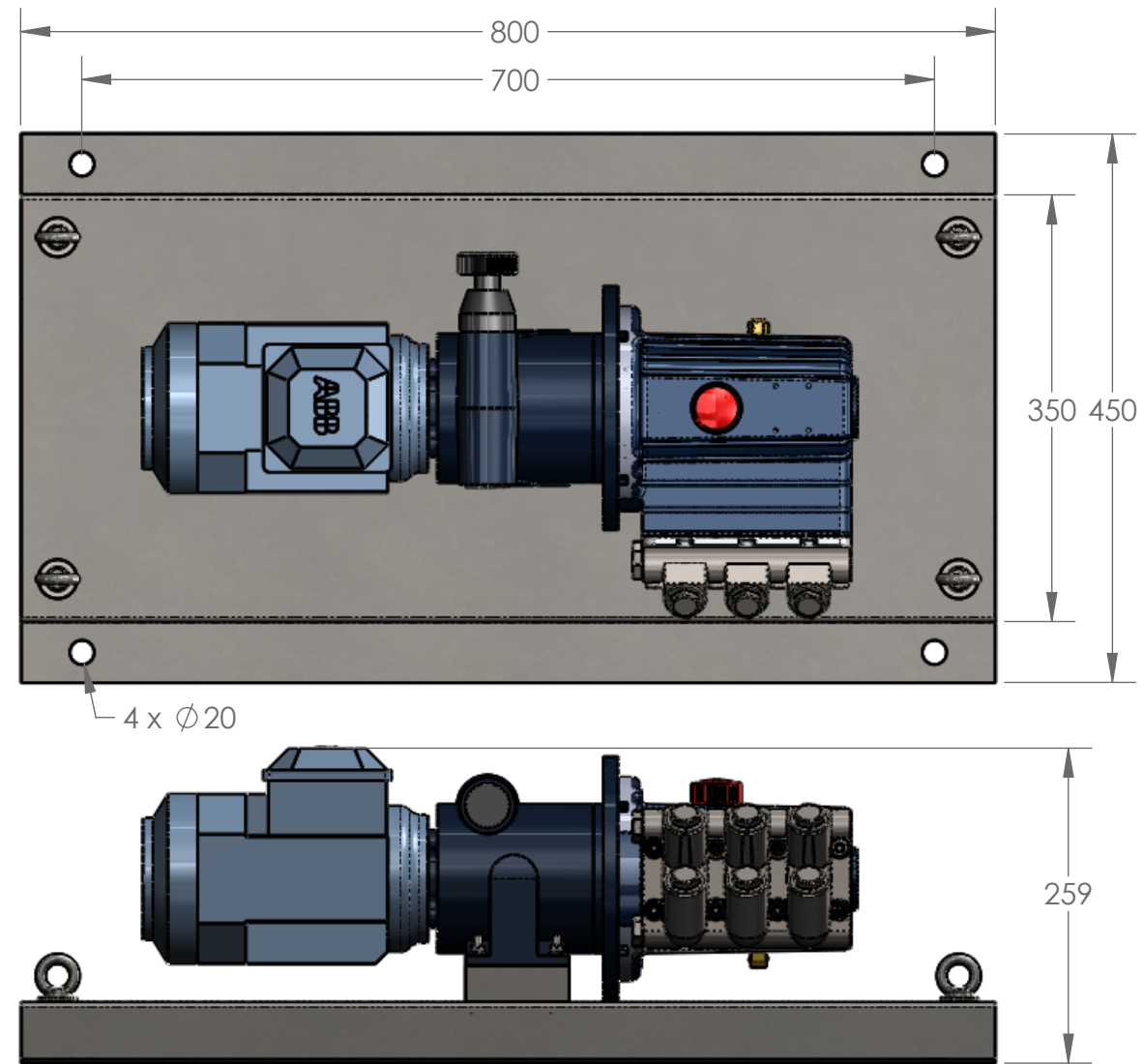

Unit Weight = 45 Kg